



SCALA2



<http://qr.grundfos.com/i/scala2install>

be
think
innovate

GRUNDFOS 

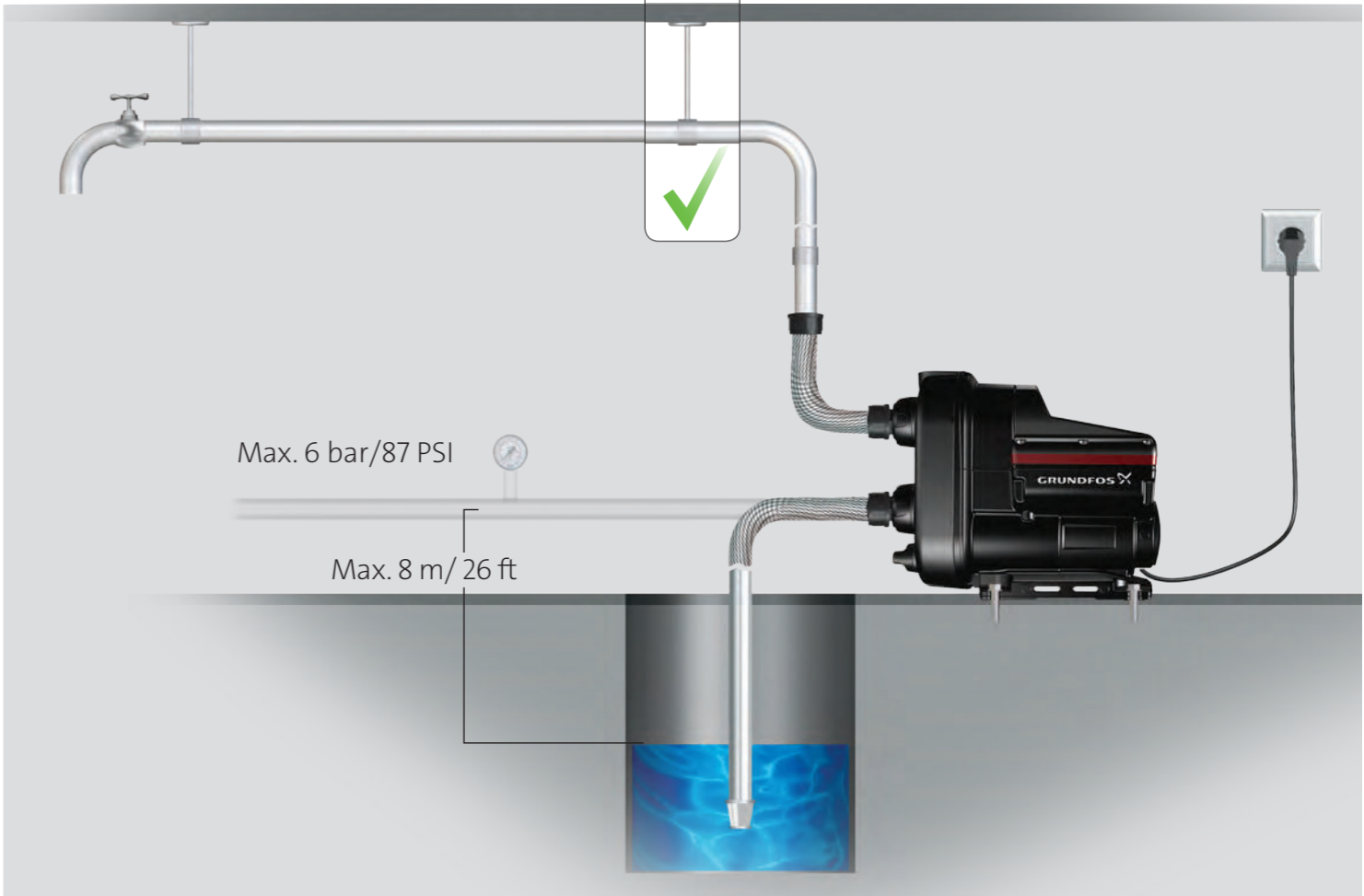
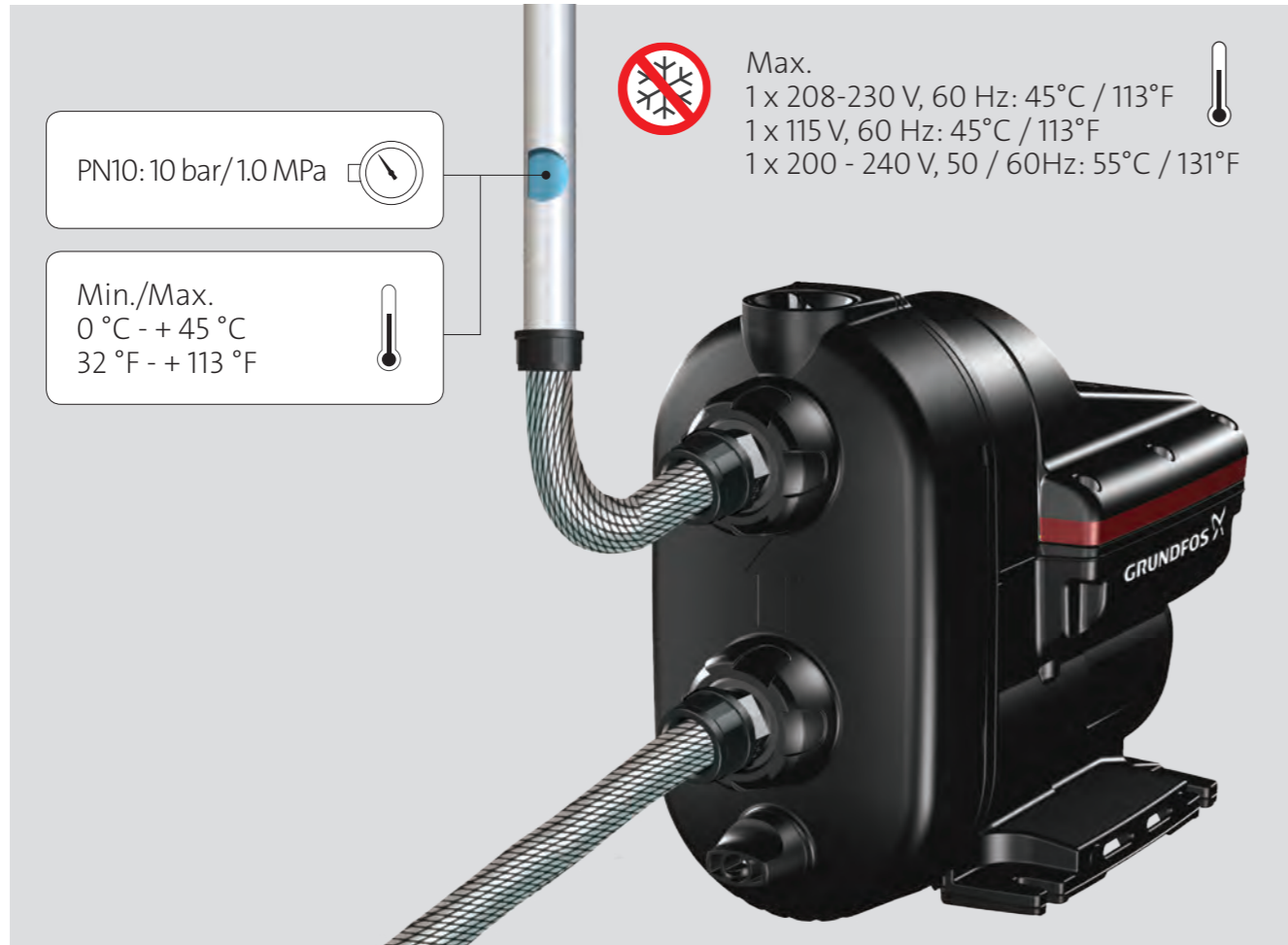
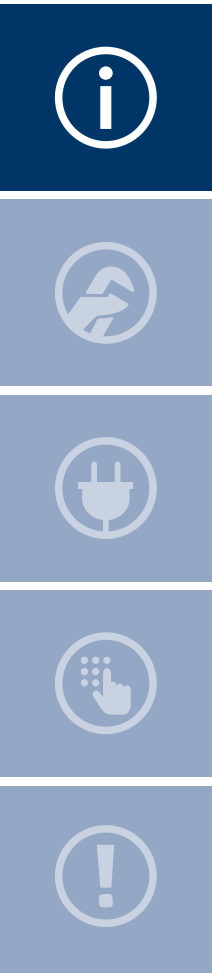

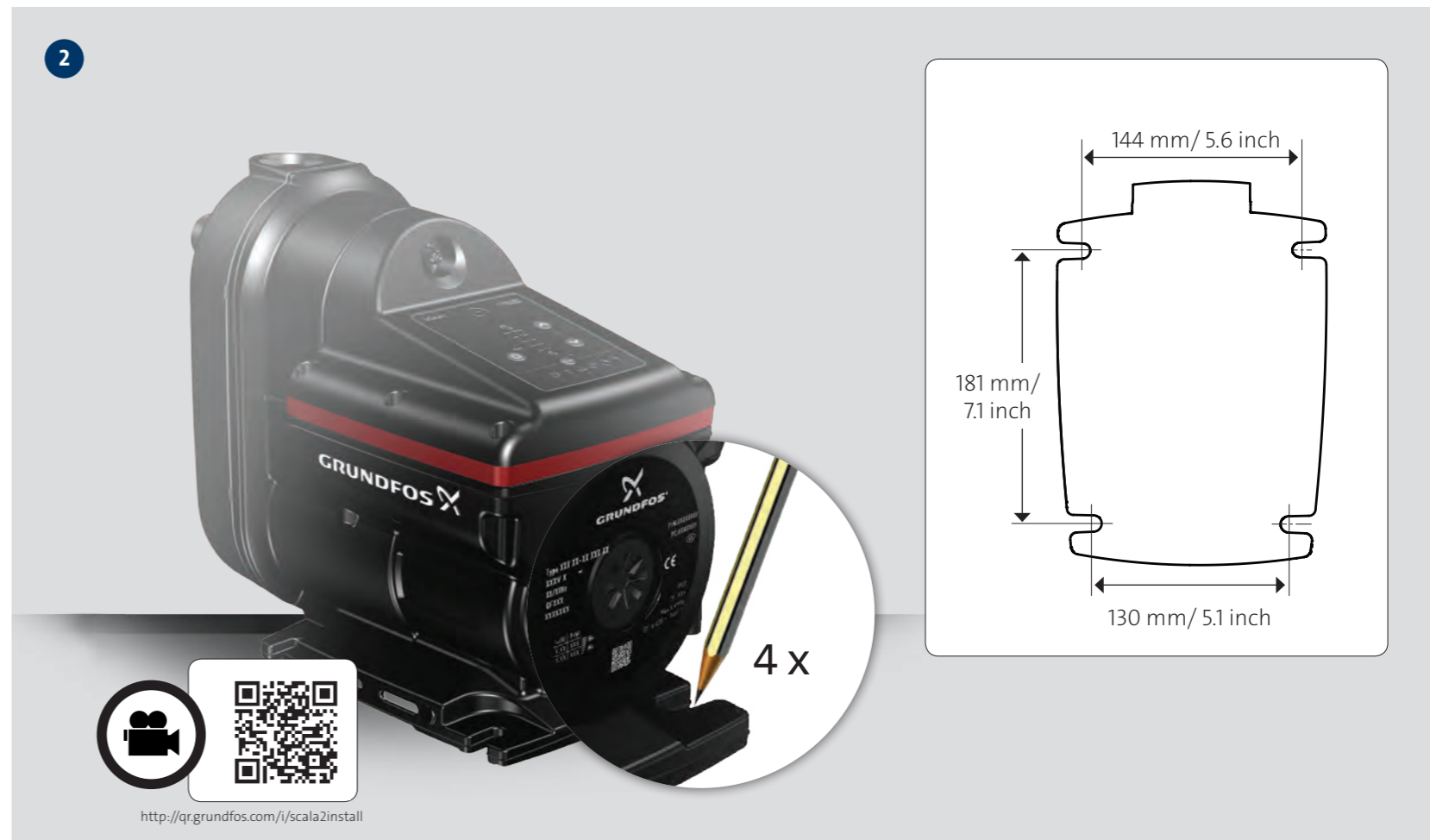
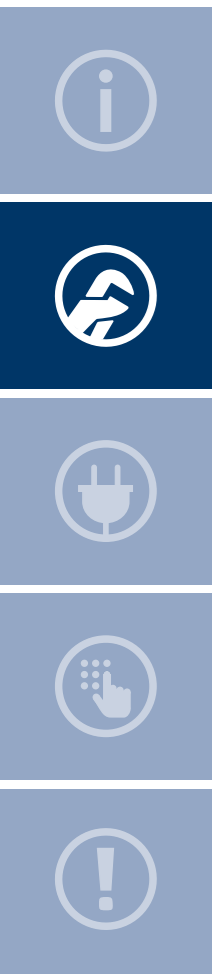

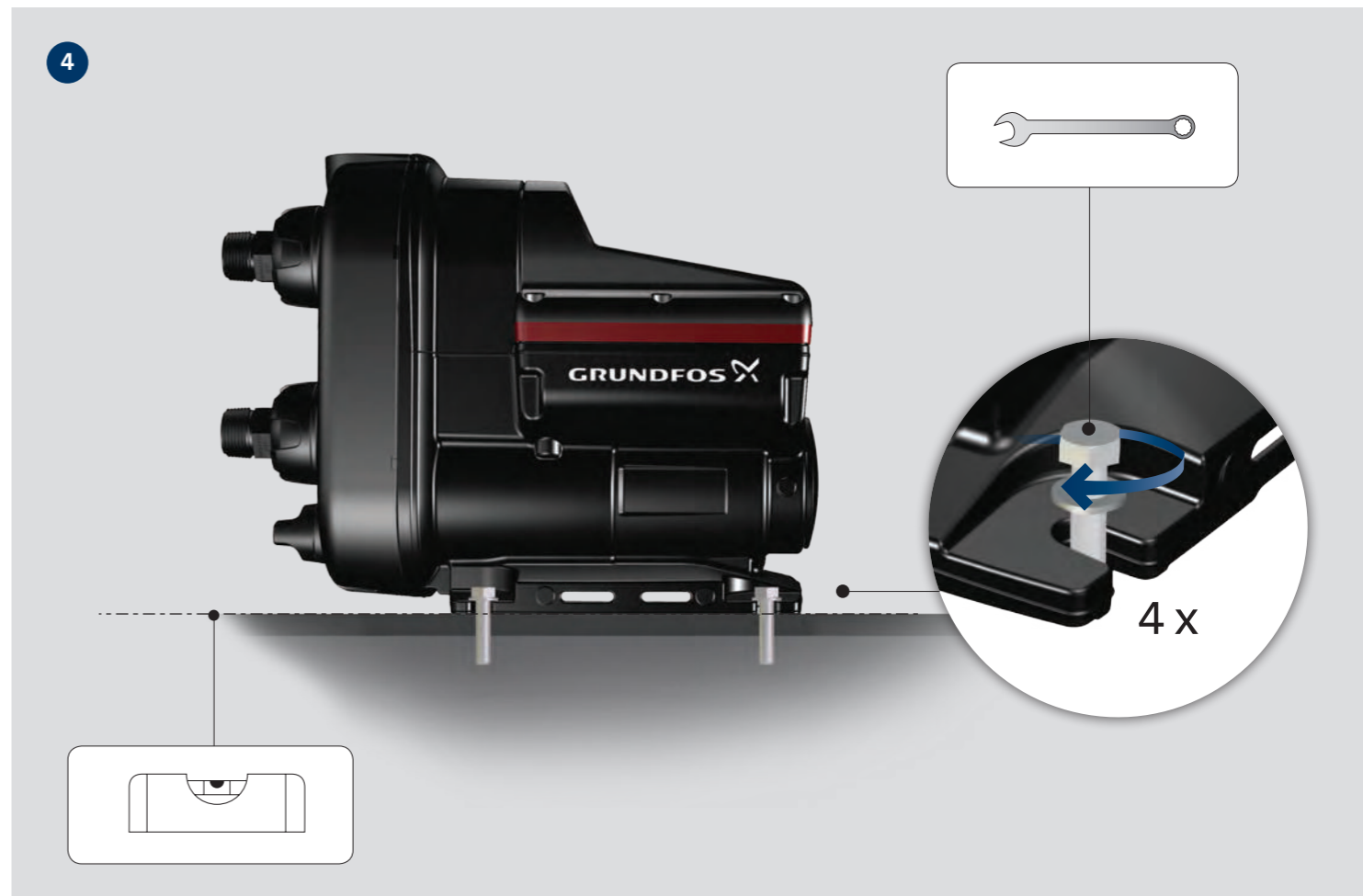
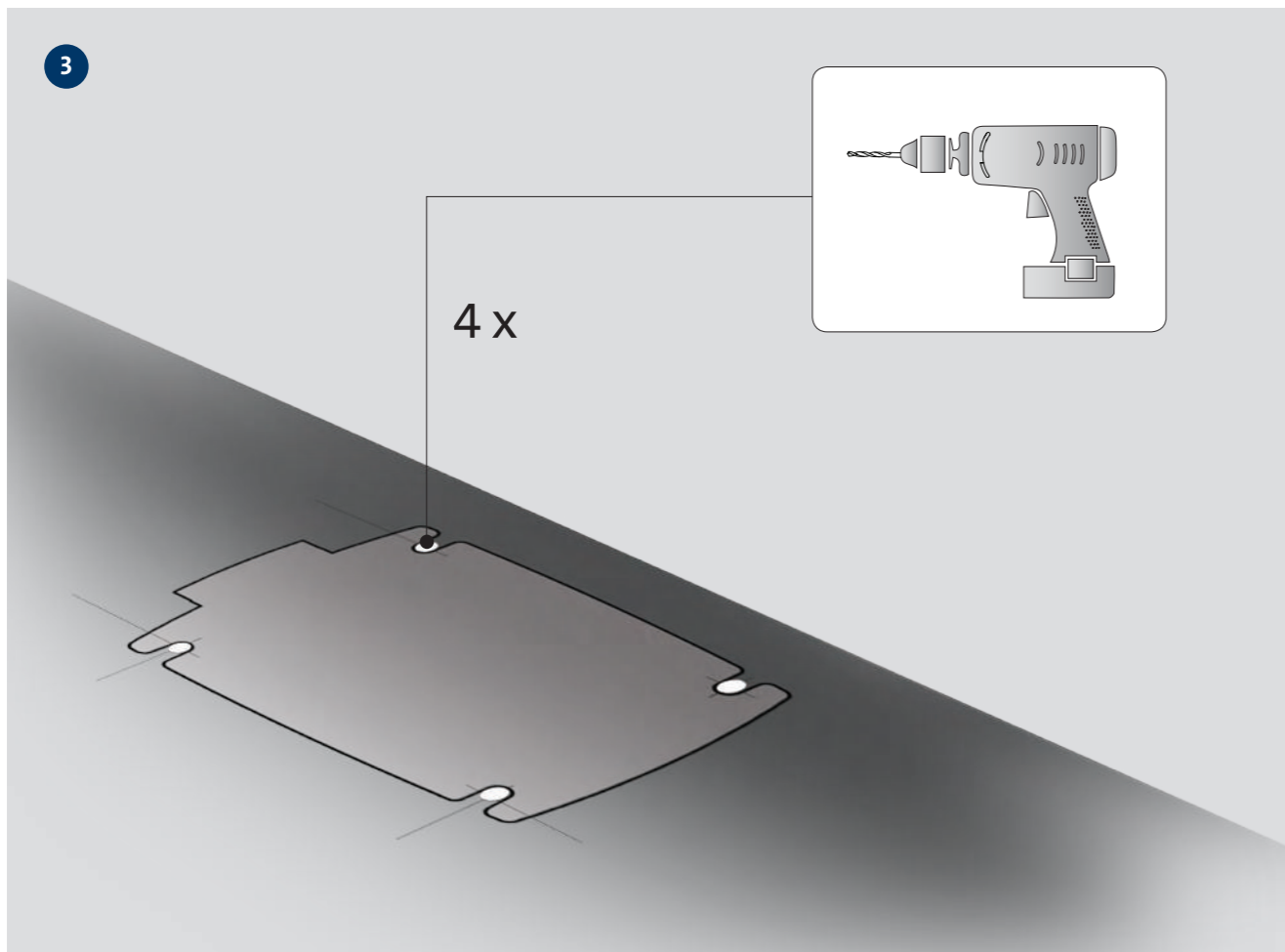
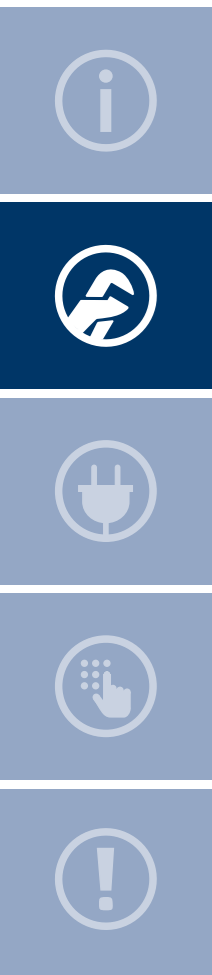

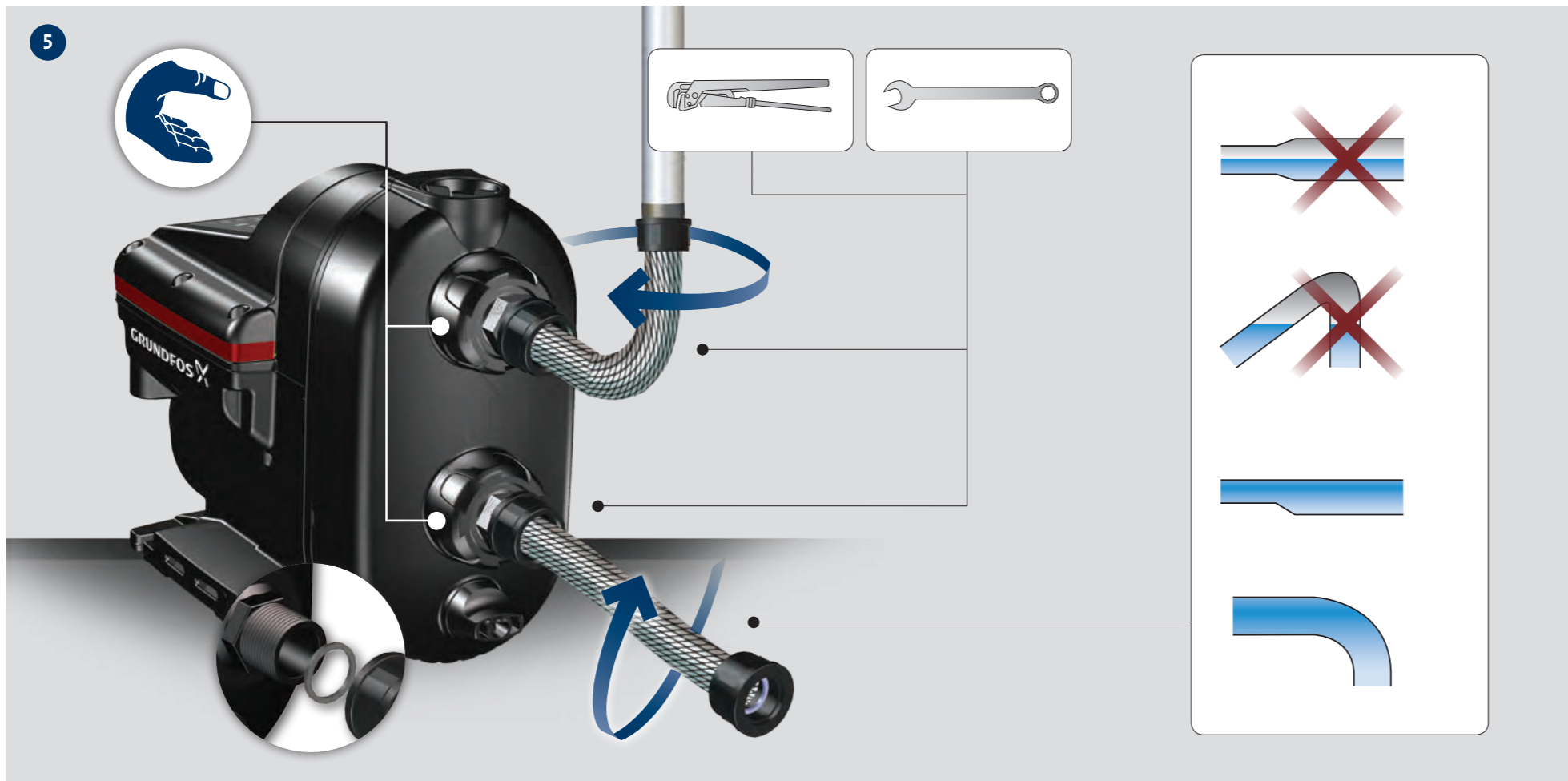
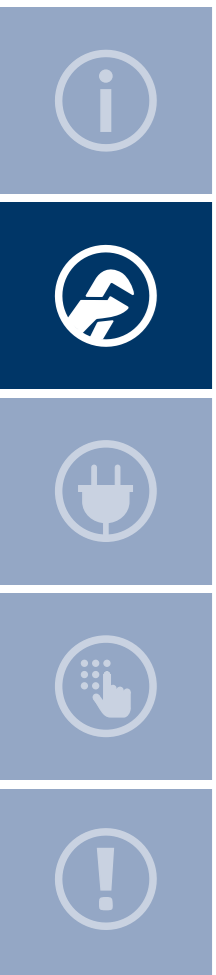

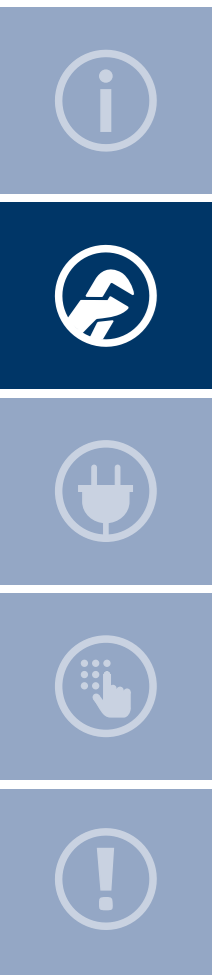

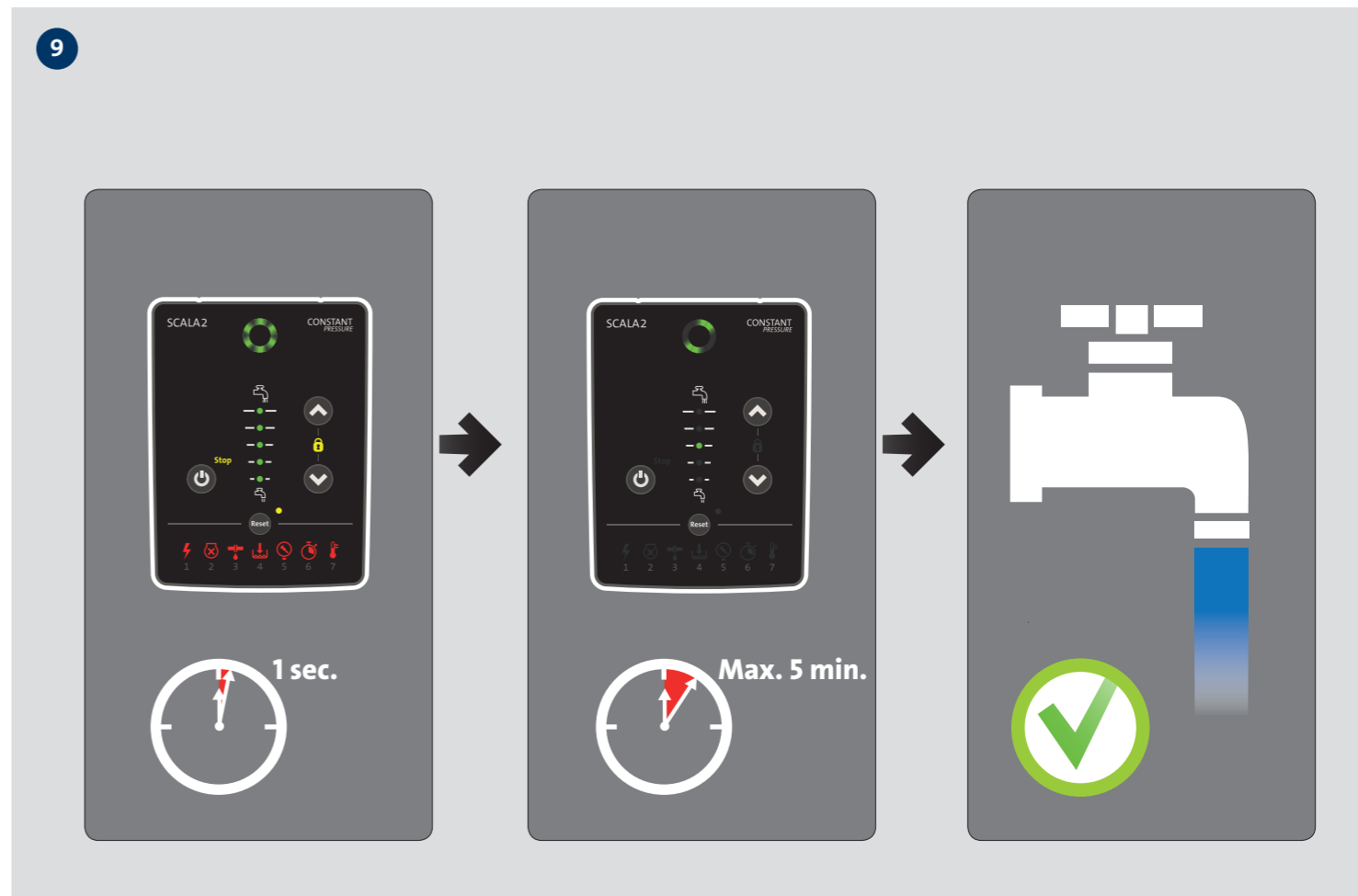
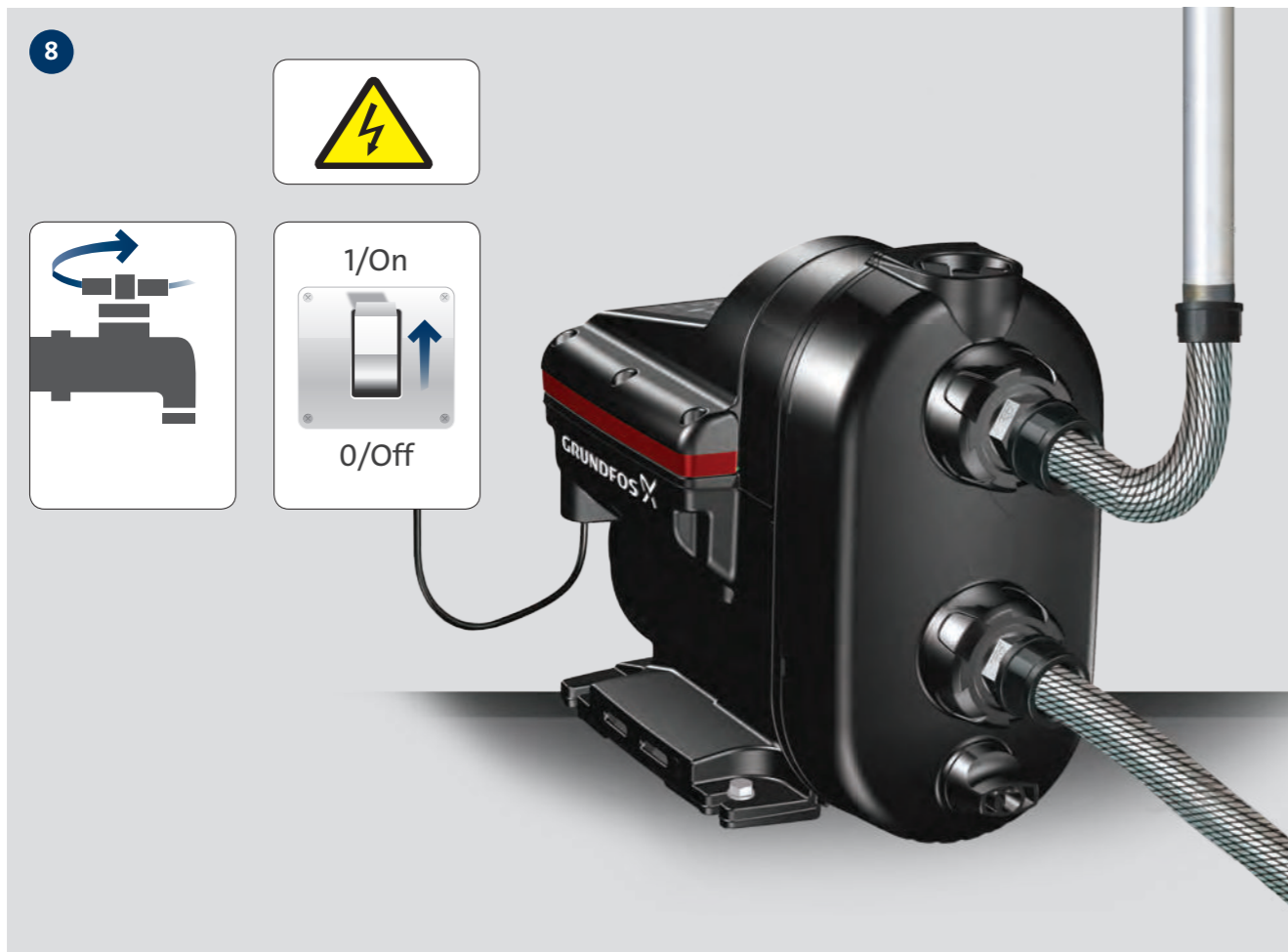
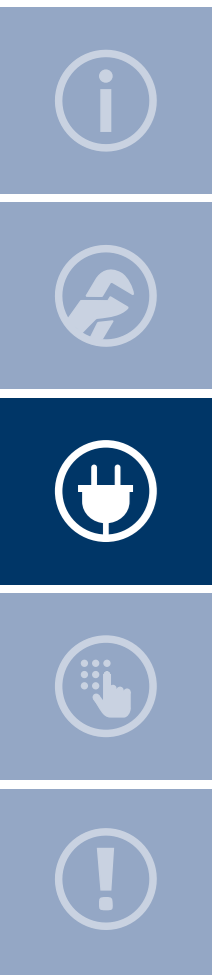

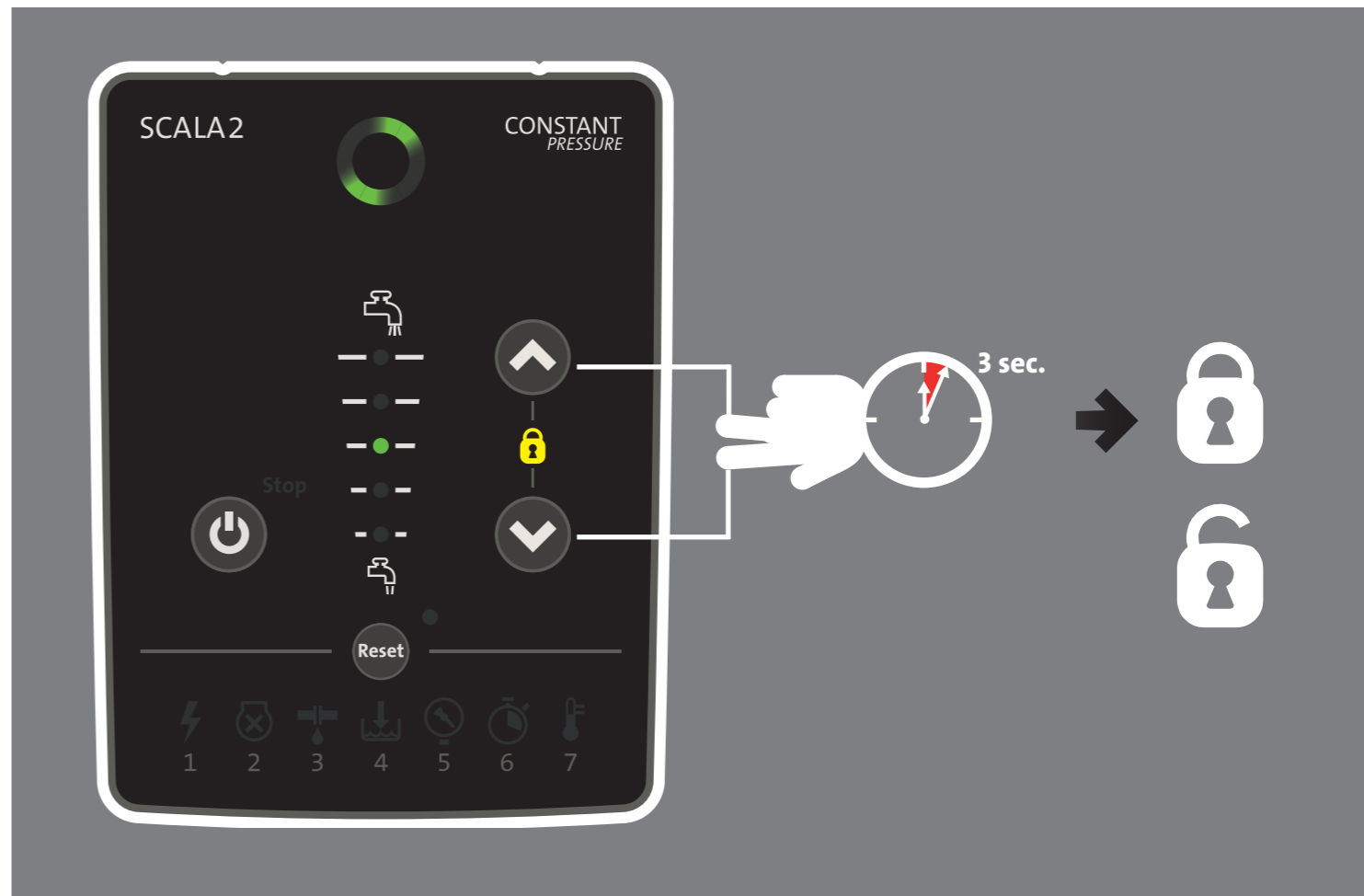
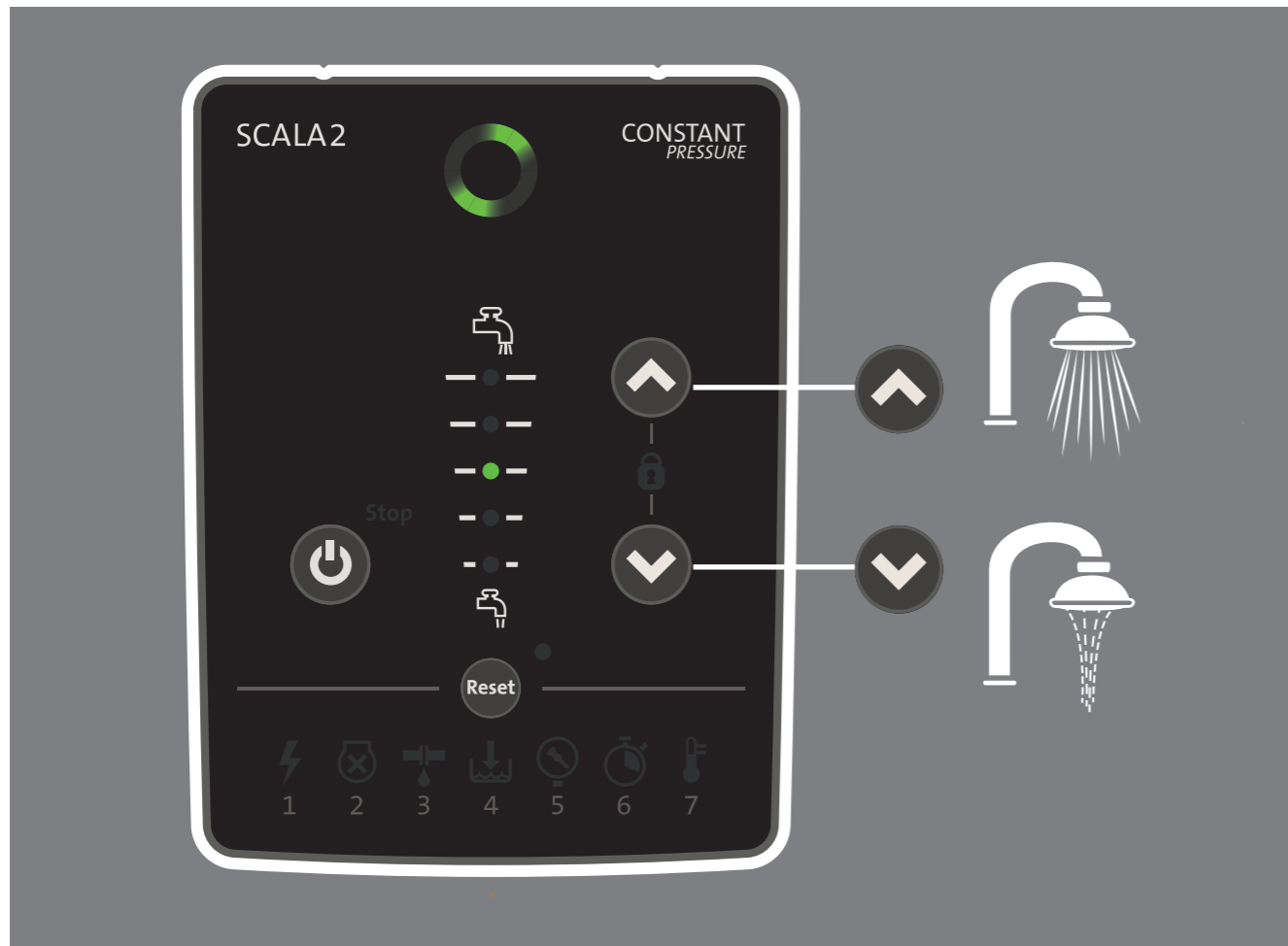
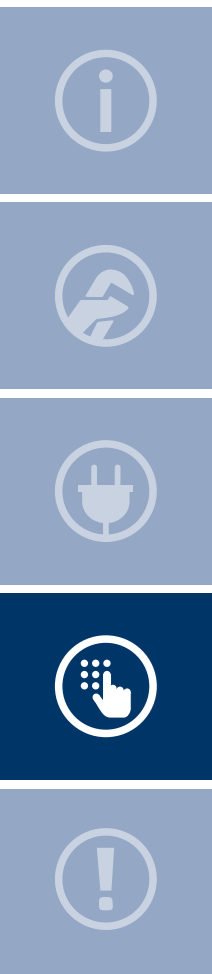

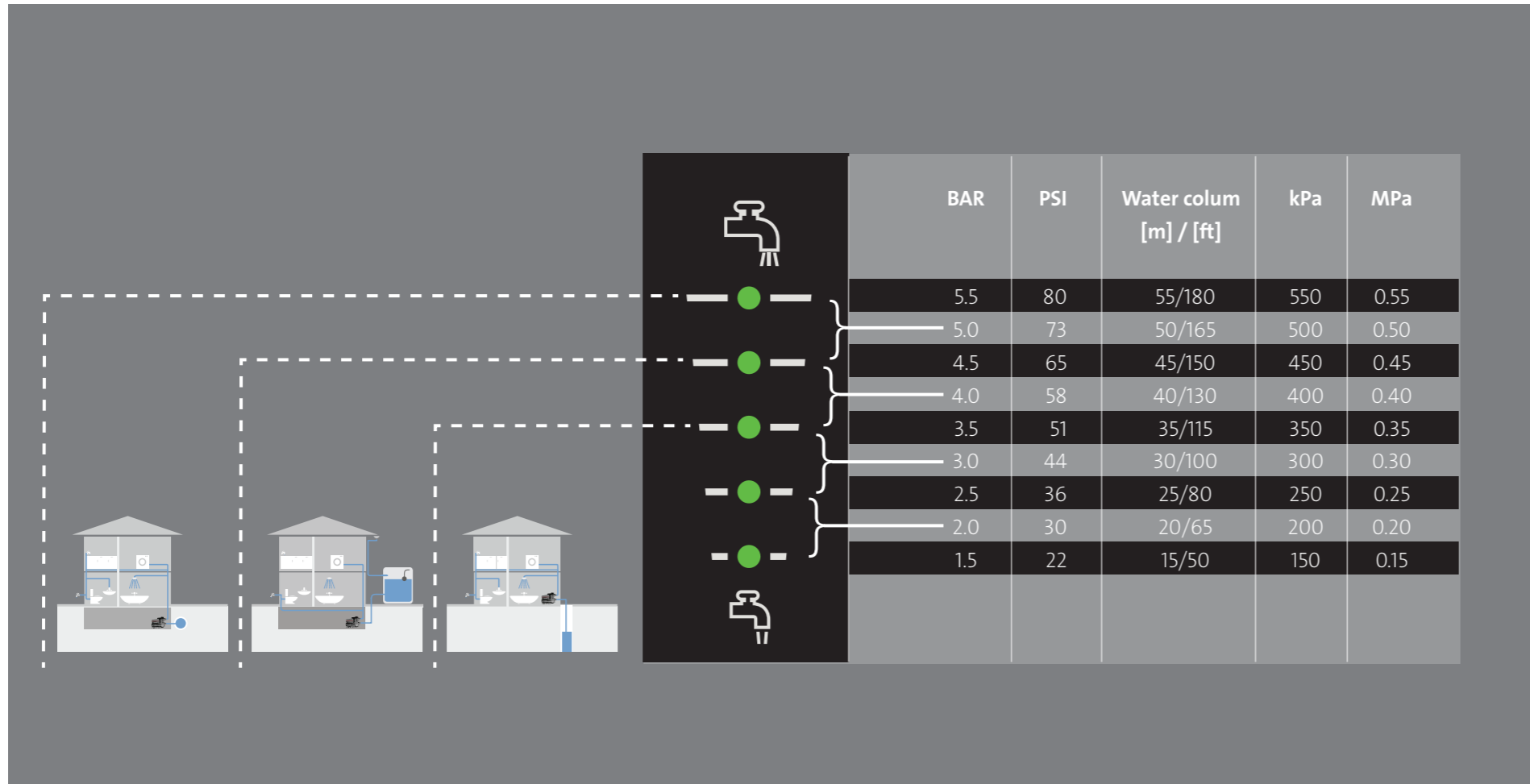
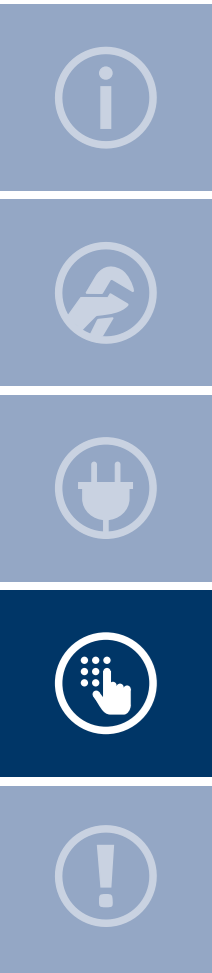

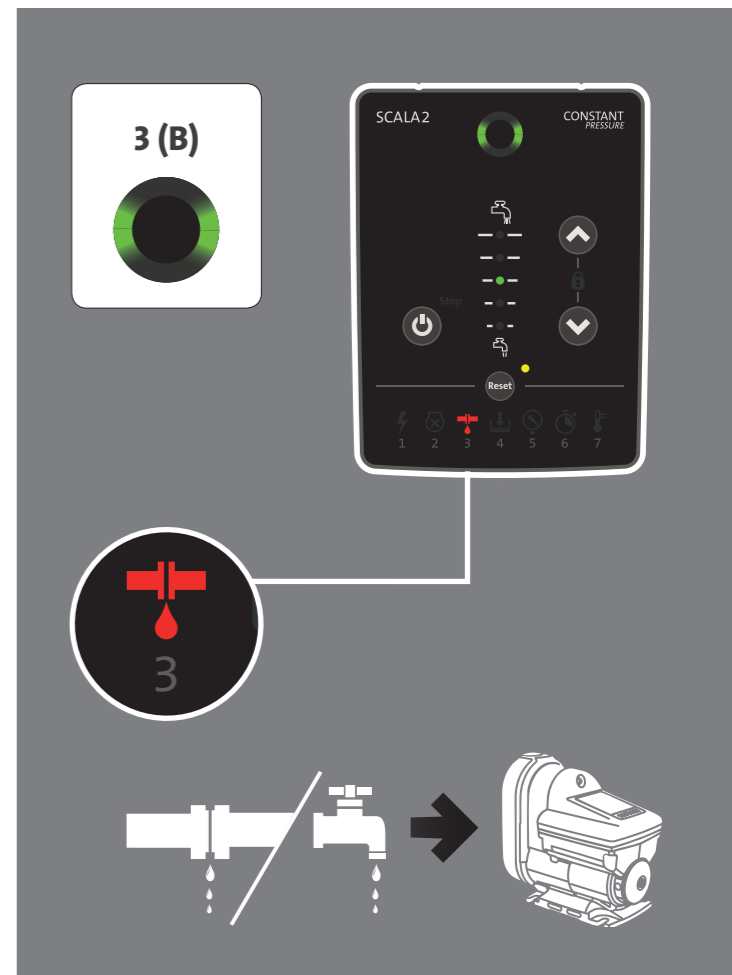
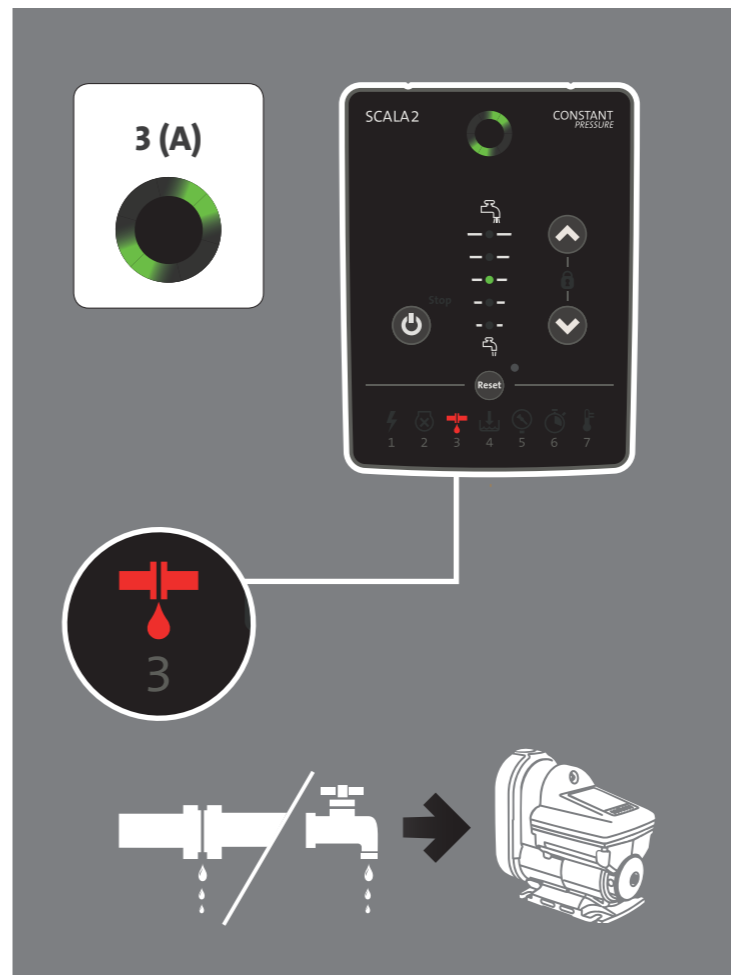
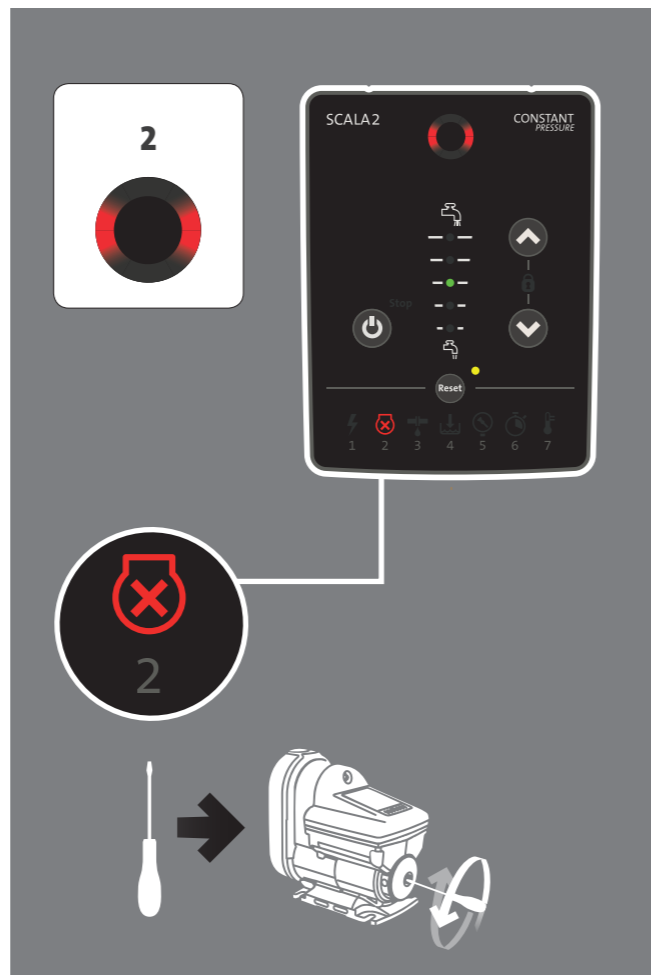
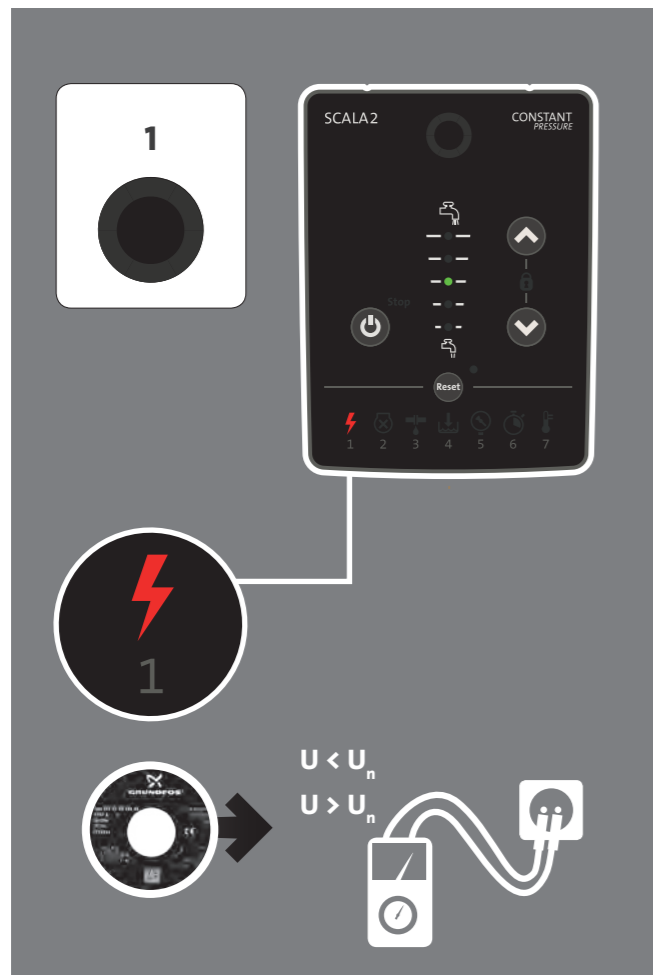
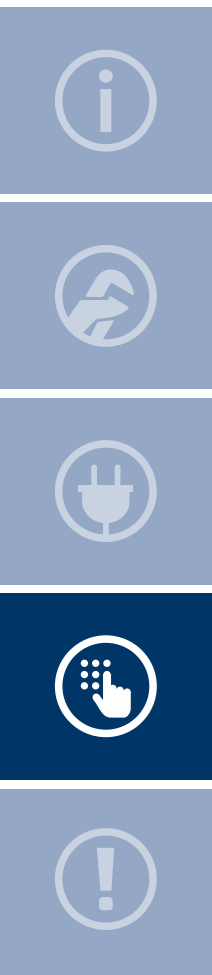

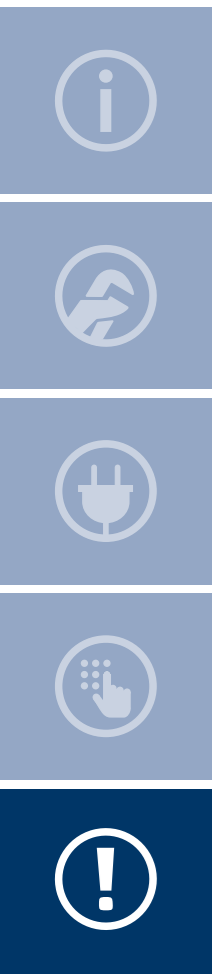

4

4

5

5

6

6

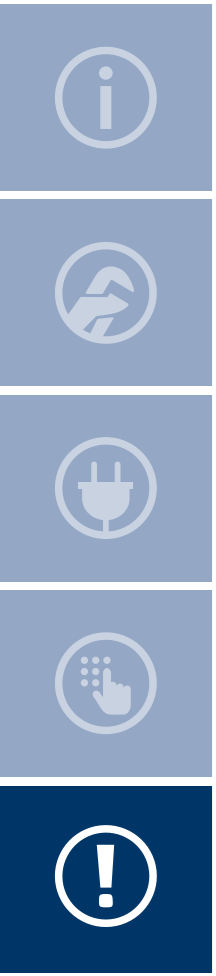

7 (A)

SCALA2 CONSTANT PRESSURE

7

Diagram illustrating the SCALA2 control panel in '7 (A)' mode. The panel shows a green indicator light and the text 'SCALA2 CONSTANT PRESSURE'. Below the panel, a circular icon with a red thermometer and the number '7' is shown. A diagram below that shows a pump unit with a snowflake icon and a hot water icon, indicating a transition from cold to hot water.

7 (B)

SCALA2 CONSTANT PRESSURE

7

Diagram illustrating the SCALA2 control panel in '7 (B)' mode. The panel shows a red indicator light and the text 'SCALA2 CONSTANT PRESSURE'. Below the panel, a circular icon with a red thermometer and the number '7' is shown. A diagram below that shows a pump unit with a red thermometer icon, indicating a hot water mode.

GRUNDFOS X

Legend of icons:

- 1: Lightning bolt (power)
- 2: Shield with X (protection)
- 3: Water drop (leak)
- 4: Water level (water level)
- 5: Hand with arrow (manual control)
- 6: Alarm clock (alarm)
- 7: Thermometer (temperature)

QR code: net.grundfos.com/qr/i/98880508

Diagram showing the GRUNDFOS X pump unit. A legend of icons is displayed above the unit, numbered 1 through 7. A QR code is shown below the unit, with the URL net.grundfos.com/qr/i/98880508 below it.

be think innovate

98501666 0416

ECM: 1183347

GRUNDFOS Holding A/S
Poul Due Jensens Vej 7
DK-8850 Bjerringbro
Tel: +45 87 50 14 00
www.grundfos.com

GRUNDFOS 

The name Grundfos, the Grundfos logo, and be think innovate are registered trademarks owned by Grundfos Holding A/S or Grundfos A/S, Denmark. All rights reserved worldwide.